

RINGOLD ALLEY
SAN FRANCISCO, CA



NO.	DATE	REVISIONS

PROJECT NO. 1314
DATE AUGUST 03, 2015
SCALE AS SHOWN

DRAWING TITLE
**SCHEMATIC
VIGNETTE**

SHEET NO.
L0.0

1 RINGOLD ALLEY @ 8TH STREET - PROPOSED CONCEPT



RAISED CROSSWALK WITH FEATURE PAVING



CHUCK ARNETT'S MURAL FROM TOOL BOX



ETCHED GRANITE HISTORIC INFORMATION MARKER

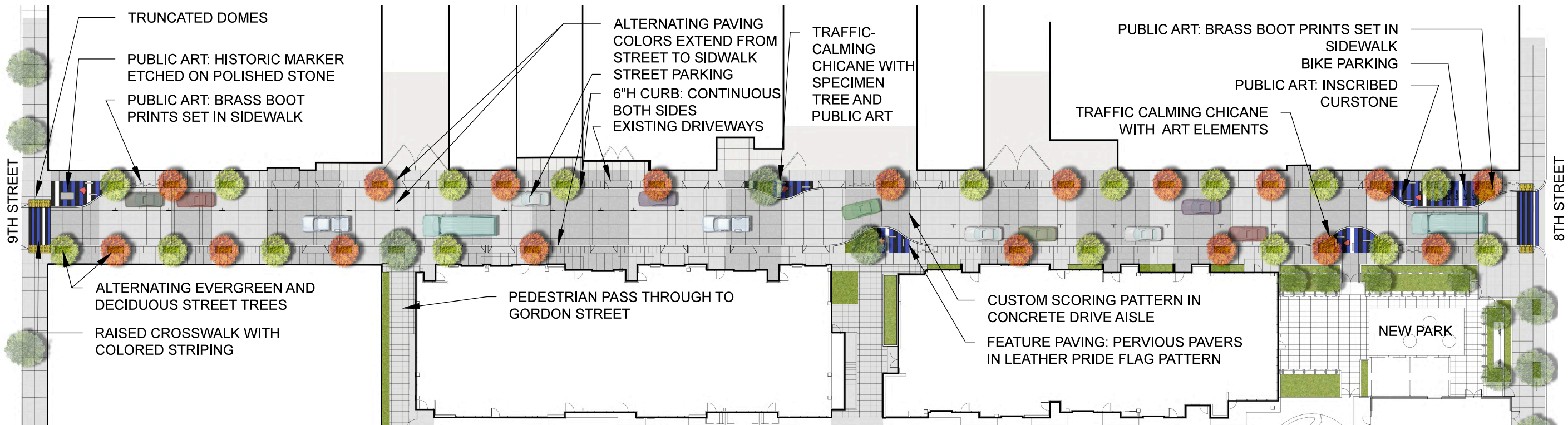

1 RINGOLD ALLEY LANDSCAPE PLAN
SCALE: 1" = 40'-0"

RINGOLD ALLEY
SAN FRANCISCO, CA

NO.	DATE	REVISIONS

PROJECT NO. 1314
DATE AUGUST 03, 2015
SCALE AS SHOWN

DRAWING TITLE
LANDSCAPE PLAN

SHEET NO.
L1.0



ETCHED CURBSTONE MARKERS



BRASS BOOT PRINTS SET IN SIDE WALK



FEATURE PAVING AT FOCAL POINTS ALONG ALLEY



FEATURE PAVING AT CROSSWALKS

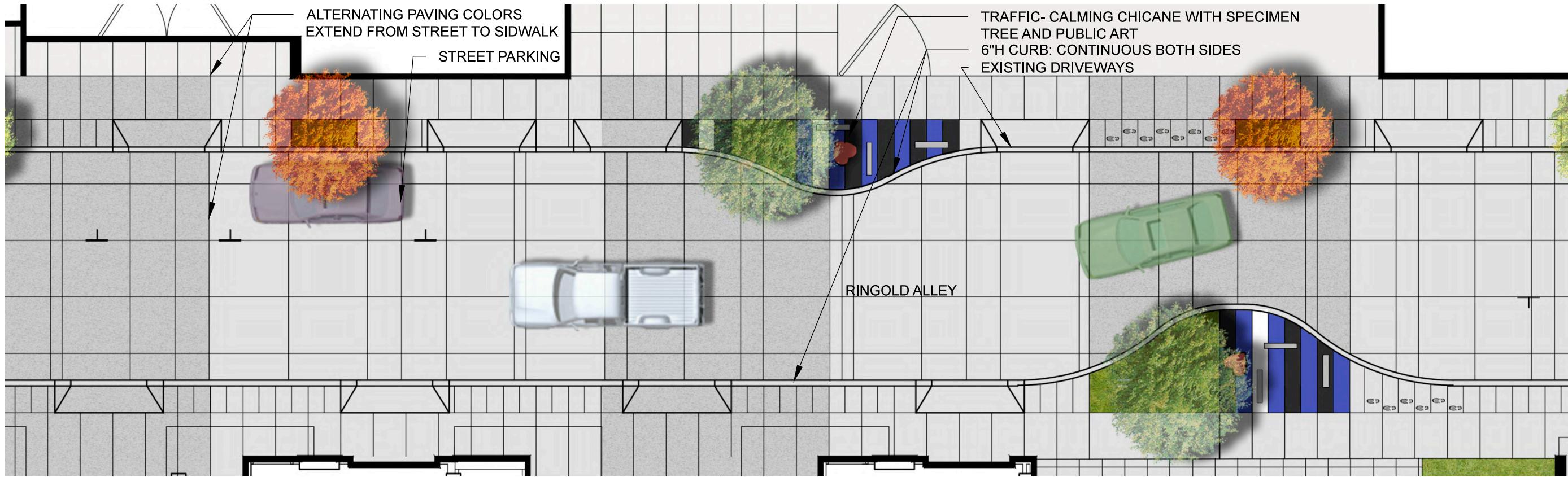

1 MID-BLOCK RINGOLD DETAIL PLAN
SCALE: 1" = 10'-0"

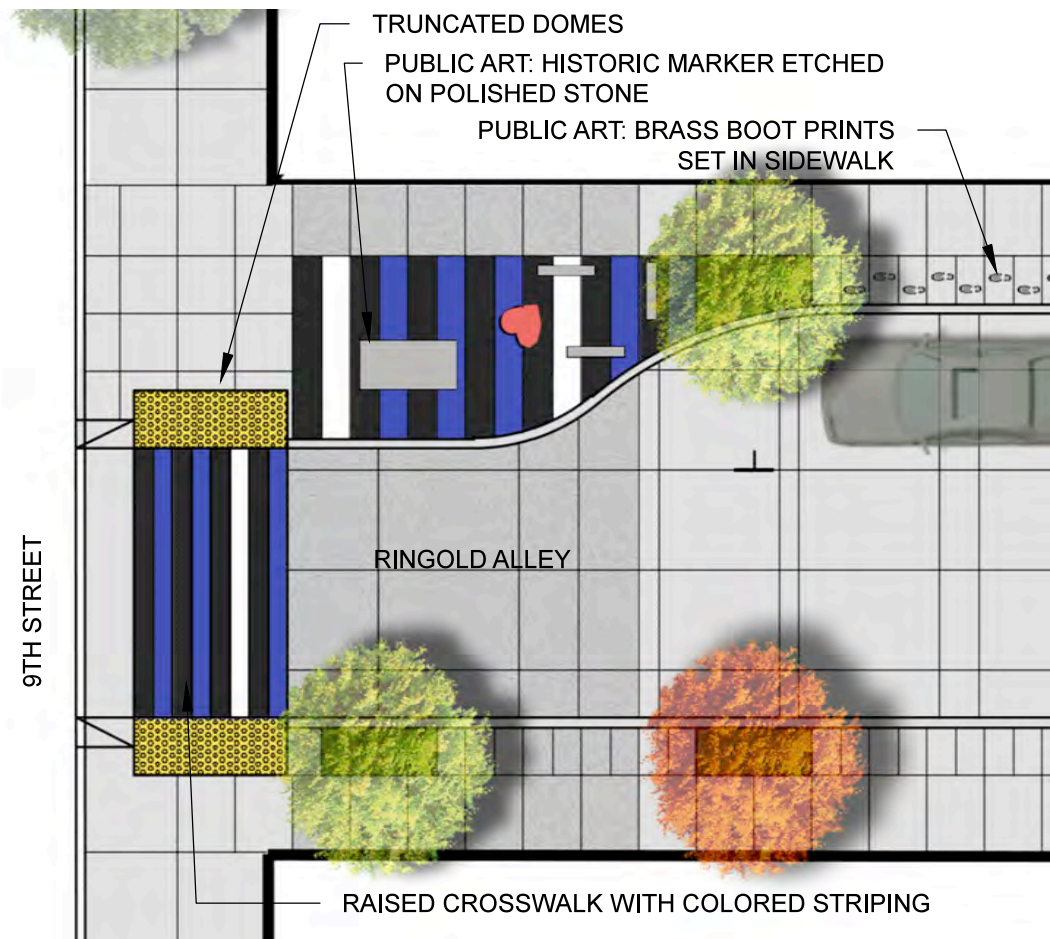

2 9TH STREET & RINGOLD DETAIL PLAN
SCALE: 1" = 10'-0"

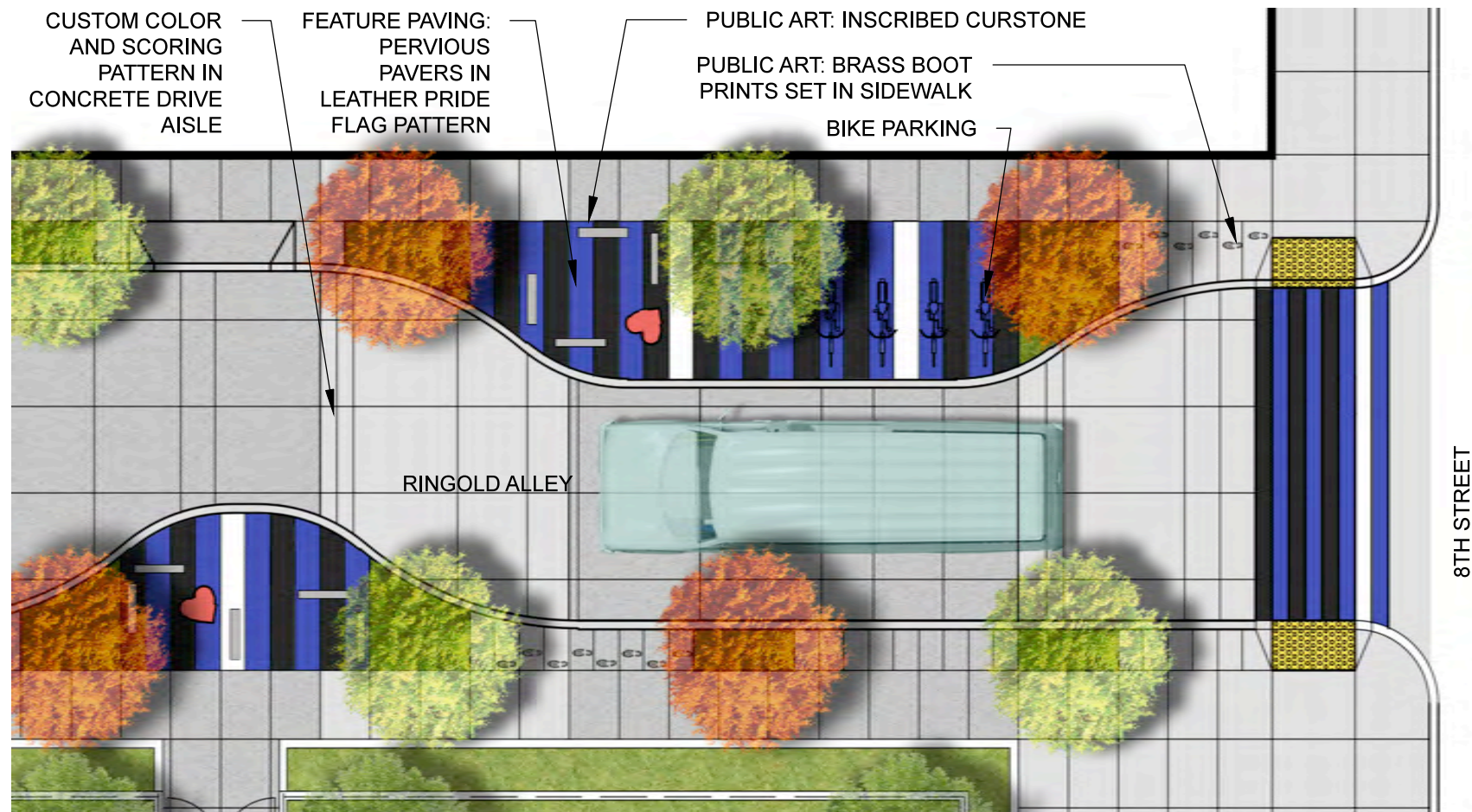

3 8TH STREET & RINGOLD DETAIL PLAN
SCALE: 1" = 10'-0"

RINGOLD ALLEY
SAN FRANCISCO, CA

NO.	DATE	REVISIONS

NO.	DATE	REVISIONS

PROJECT NO. 1314
DATE AUGUST 03, 2015
SCALE AS SHOWN

DRAWING TITLE
LANDSCAPE PLAN
BLOWUPS

SHEET NO.
L1.1

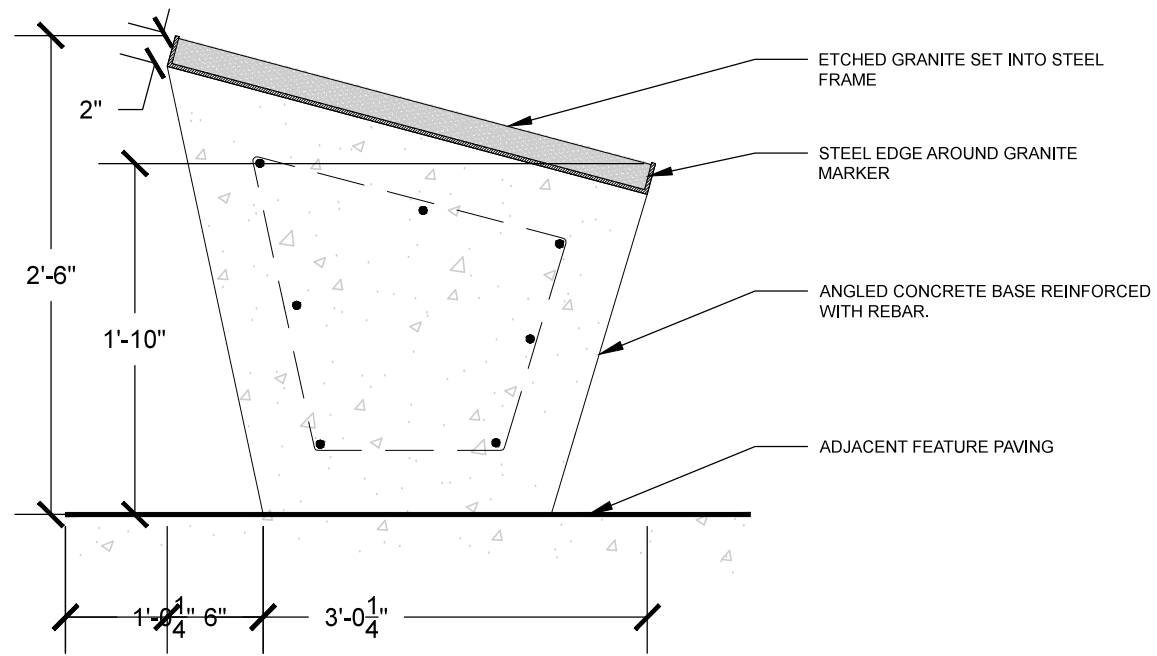

SECTION

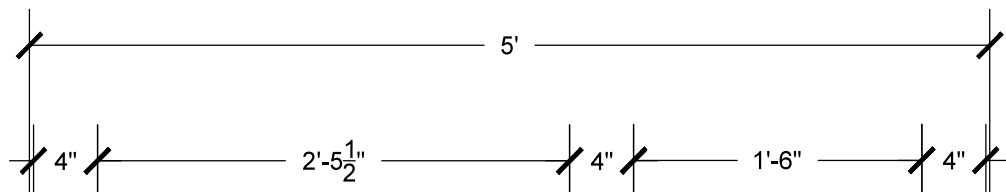

PLAN

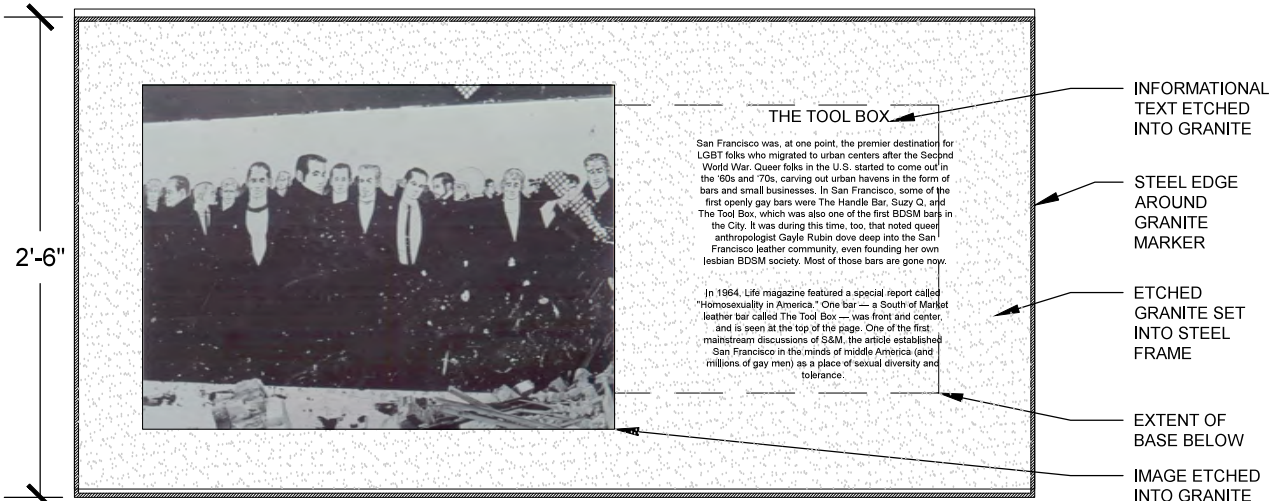

1 HISTORIC MARKER

SCALE: 1"=1'-0"

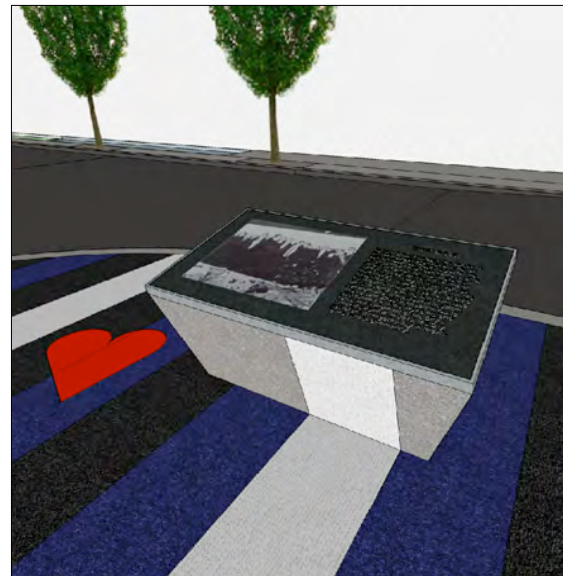

CONCEPT IMAGE: MARKER SCHEMATIC



CONCEPT IMAGE: MARKER SCHEMATIC



THE TOOL BOX: MID DEMOLITION

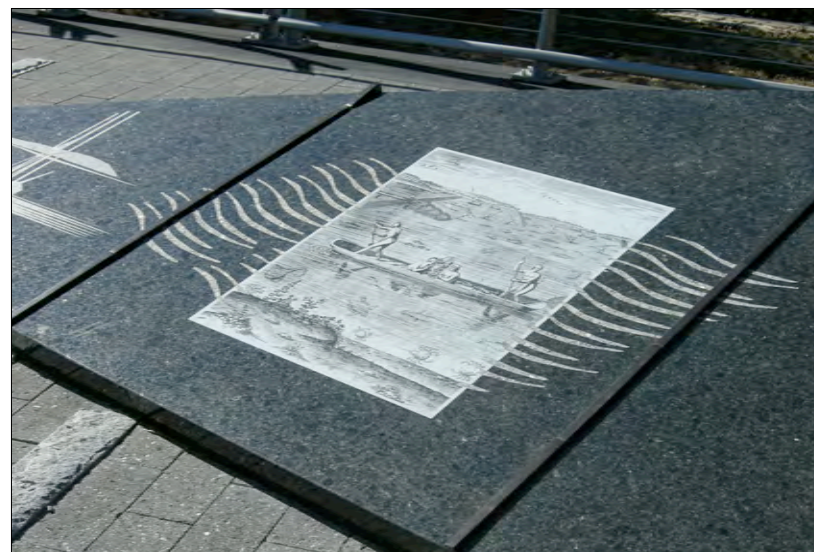

PRECEDENT IMAGE: ETCHED GRANITE MARKER

ETCHED GRANITE MARKER NEAR THE INTERSECTION OF 9TH AND RINGOLD FEATURING A REPLICA OF CHUCK ARNETT'S FAMOUS MURAL FROM THE TOOL BOX PROVIDES A BRIEF HISTORY OF THE NEIGHBORHOOD'S UNIQUE CULTURAL HISTORY AND INVITES PASSERSBY TO EXPLORE OTHER ASPECTS OF THE ALLEY

RINGOLD ALLEY SAN FRANCISCO, CA

NO.	DATE	REVISIONS

PROJECT NO.	1314
DATE	AUGUST 03, 2015
SCALE	AS SHOWN

DRAWING TITLE
SCHEMATIC DETAIL - HISTORIC MARKER

SHEET NO.
L2.0

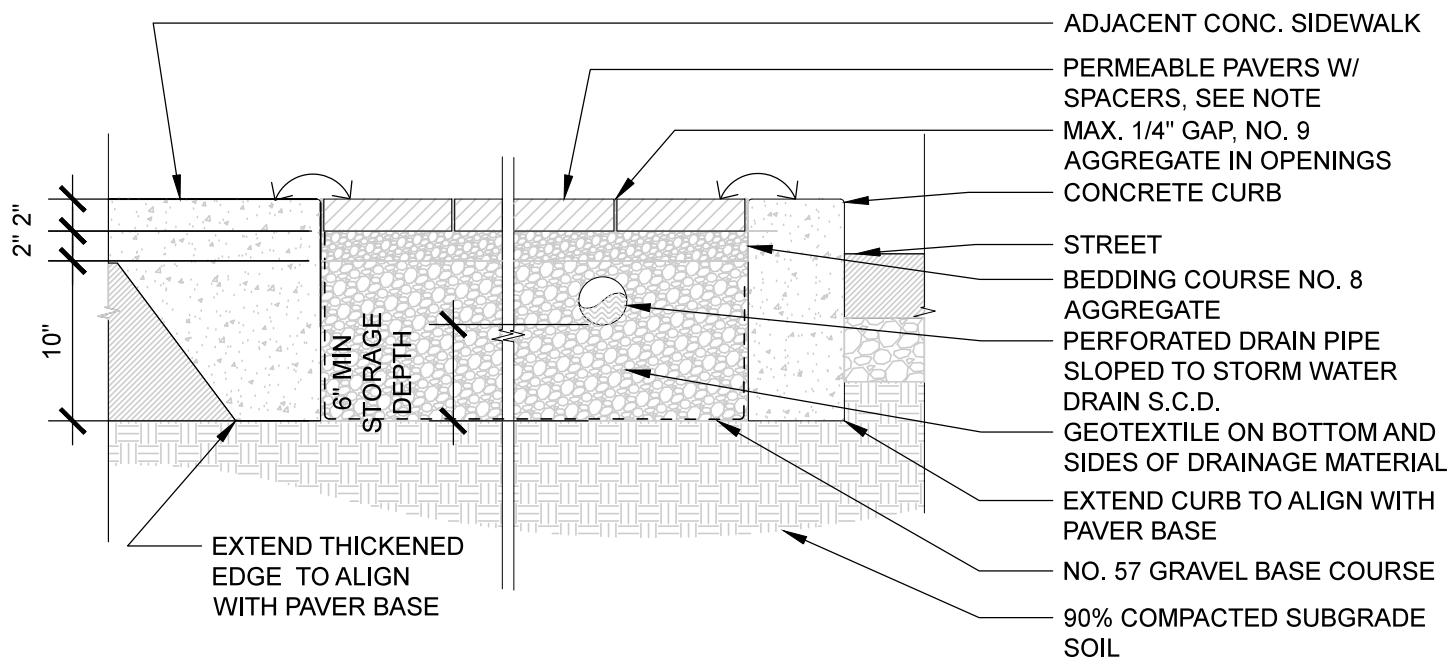

CONCEPT IMAGE: LEATHER PRIDE FLAG

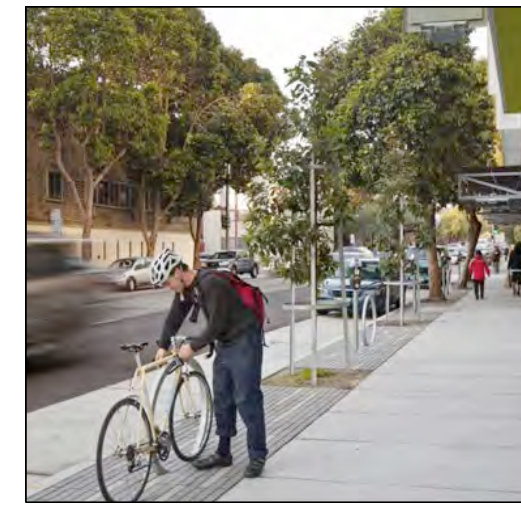

CONCEPT IMAGE: PERMEABLE PAVERS

PERMEABLE PAVERS LOCATED OUTSIDE THE SIDEWALK PATH OF MOVEMENT AT THE PROPOSED CHICANES INVOKE THE LEATHER PRIDE FLAG, PROVIDE VISUAL INTEREST, REDUCE RUN OFF, AND DEMARCATATE AREAS DESIGNATED FOR GATHERING

1 PERMEABLE PAVERS @ STREETScape
SCALE: 1"=1'-0"

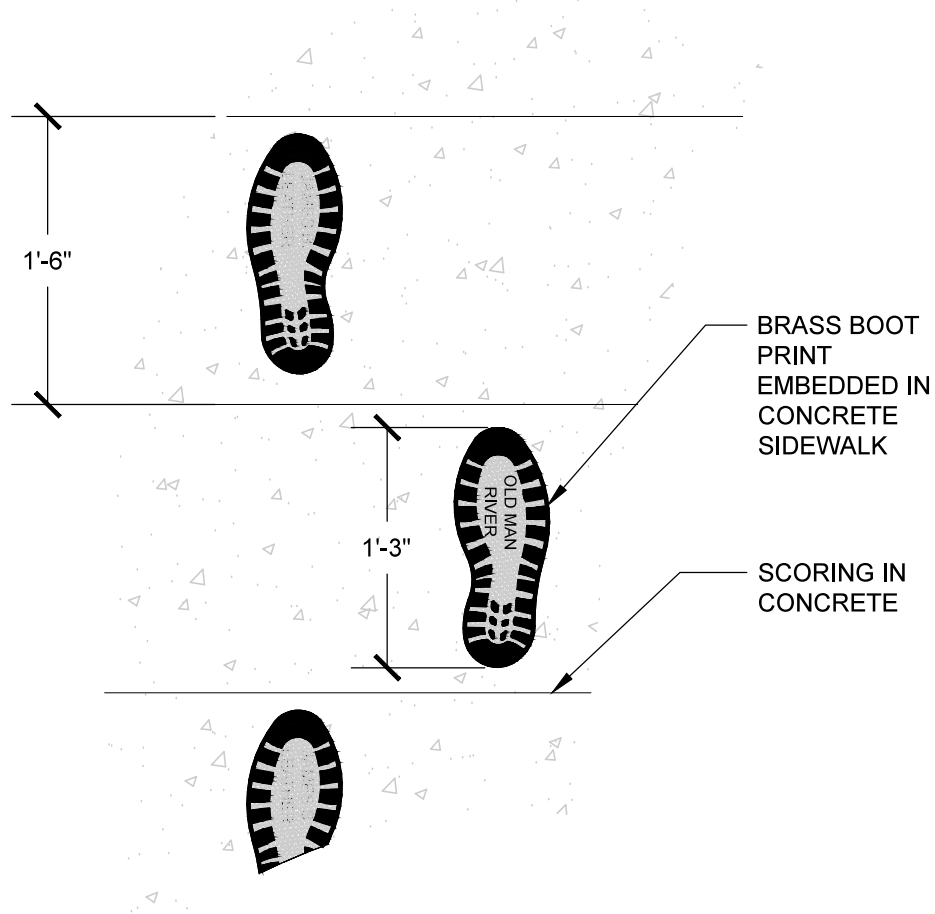

PRECEDENT: DANCING STEPS, SEATTLE, WA



CONCEPT IMAGE

BRASS FOOT PRINTS SET INTO THE SIDEWALK AT VARIOUS LOCATIONS ALONG RINGOLD ALLEY COMMEMORATE SOME OF THE KEY FIGURES WHO PLAYED A ROLE IN THE HISTORY OF FOLSOM'S LEATHER PRIDE MOVEMENT

2 EMBEDDED BRASS BOOT PRINT
SCALE: 1"=1'-0"

NO.	DATE	REVISIONS

PROJECT NO.	1314
DATE	AUGUST 03, 2015
SCALE	AS SHOWN

DRAWING TITLE
SCHEMATIC DETAIL - BOOT PRINTS & PERVIOUS PAVERS

SHEET NO.
L2.1

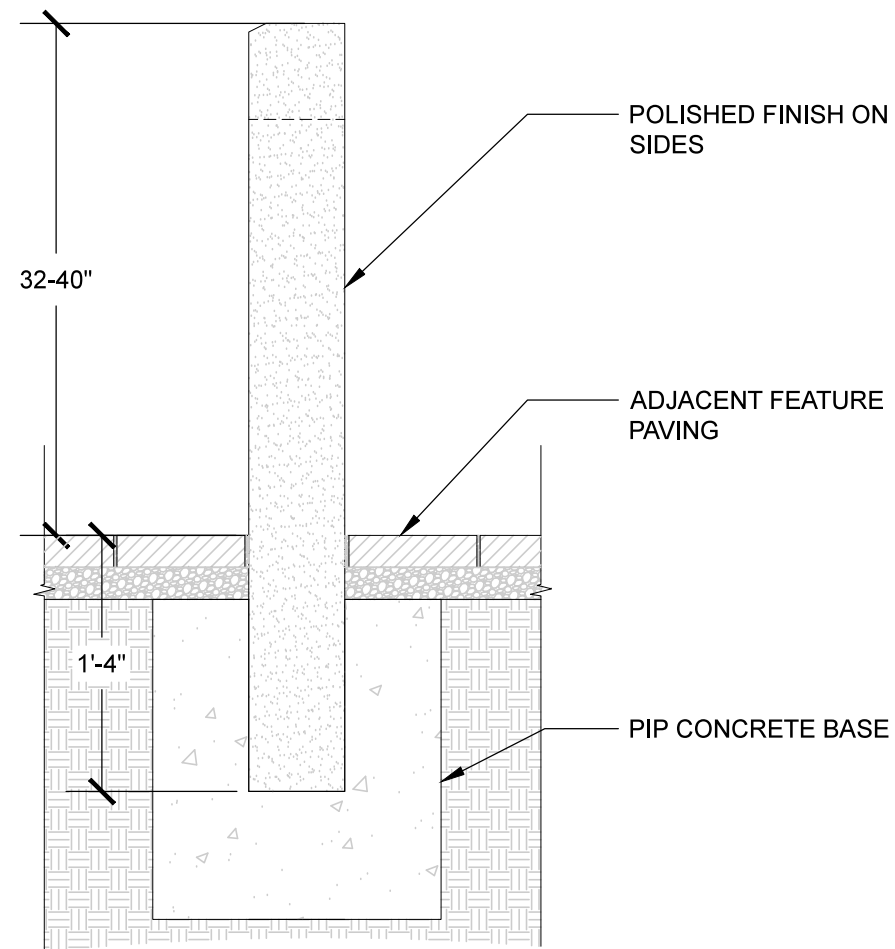
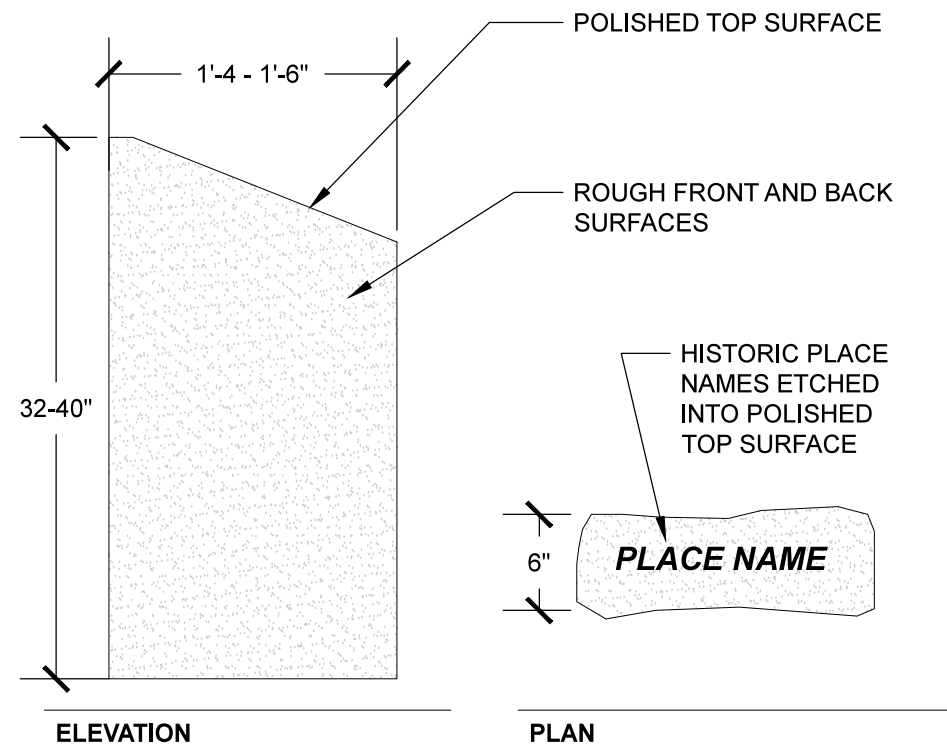

CONCEPT IMAGE: LEATHER PRIDE FLAG



SALVAGED CURB STONE PIECES



PRECEDENT IMAGE: CARVED STONE TOTEM

SALVAGED CURBSTONE MARKERS WITH ROUGH FACES AND POLISHED SIDES/TOP COMMEMORATE IMPORTANT PLACES IN THE NEIGHBORHOOD'S LEATHER CULTURE WHILE GIVING THE ALLEY A UNIQUE SYMBOL. USE OF OLD CURBSTONE PIECES CELEBRATES THE CITY'S HISTORY AND ACTIVATES DESIGNATED AREAS

NO.	DATE	REVISIONS

PROJECT NO. 1314
DATE AUGUST 03, 2015
SCALE AS SHOWN

DRAWING TITLE
SCHEMATIC DETAIL -
CURB STONE

SHEET NO.
L2.2

1 ETCHED CURB STONE
SCALE: 1"=1'-0"